

Description	Specification
External dimensions (height x width)	292 mm x 292 mm
Distance between axis	239 mm x 239 mm
Lengthways tubes	Extruded alluminium EN AW 6082 T6 - Ø50x2mm
Crossways tubes	Extruded alluminium EN AW 6082 T6 - Ø18x2mm
Connecting plate	Cast alluminium EN AC 42200 T6
Welding process	TIG -141/ISO 4063
Available lenght (cm)	10.5 - 21 - 25 - 29 - 42 - 50 - 100 - 150 - 200 - 250 - 300 - 350 - 400
Connection systems	QXFC - QXSM10

Section Area	Moment of inertia Y - axis	Moment of inertia Z - axis	Selfweight (approx.)		
[mm <sup>2</sup> ]	[mm <sup>4</sup> ]	[mm <sup>4</sup> ]	[N/m]		
1206	14.939.000	14.939.000	60		

Span [m]	Centre Point Load (C.P.L.)			Third Point Load (T.P.L.)			Quarter Point Load (Q.P.L.)			Fifth Point Load (F.P.L.)			Uniformly Distributed Load (U.D.L.)		
	Point Load [kg]	Full Load [kg]	Central Deflection [mm]	Point Load [kg]	Full Load [kg]	Central Deflection [mm]	Point Load [kg]	Full Load [kg]	Central Deflection [mm]	Point Load [kg]	Full Load [kg]	Central Deflection [mm]	Load [kg/m]	Full Load [kg]	Central Deflection [mm]
1	2319	2319	0,4	1168	2337	0,3	779	2337	0,3	584	2337	0,3	2337	2337	0,2
2	1556	1556	2	998	1996	2	771	2313	2	583	2331	2	1166	2331	2
3	1157	1157	5	775	1550	6	620	1860	7	501	2006	7	775	2325	7
4	916	916	10	629	1258	12	501	1504	13	393	1573	13	530	2121	15
5	756	756	16	527	1055	19	406	1218	21	322	1289	21	342	1711	23
6	640	640	24	452	904	29	340	1020	30	272	1087	31	239	1431	34
7	553	553	34	394	788	40	291	873	42	235	939	43	175	1224	46
8	485	485	45	349	698	54	254	762	55	205	821	56	133	1061	60
9	430	430	57	311	622	70	224	673	70	182	729	72	104	933	76
10	386	386	72	280	560	87	200	600	87	163	652	90	83	830	94
11	347	347	87	253	507	106	180	540	105	147	587	109	67	741	114
12	315	315	105	231	462	128	162	487	126	133	530	130	56	667	135
13	287	287	124	211	422	152	147	442	148	121	483	154	47	607	159
14	262	262	146	193	387	177	135	404	173	110	441	179	39	550	184
15	240	240	169	178	356	205	123	369	198	101	406	207	33	500	210
16	220	220	193	164	329	235	113	338	226	93	370	235	29	461	241

Load table has been prepared in accordance with UNI ENV 1999-1-1 (Eurocode 9).  
 When calculating the allowable loads shown in the table, it is assumed that the trusses are simply supported at the end connection and that static loads will be applied to the node points.  
 The application of the load shall be on the centre line of the truss.  
 The values shown in the table are the allowable statics loads that can be applied to the truss. This is the live load or the payload.  
 The self weight of the truss has been taken into account when calculating the values in the table.  
 It should be noted that this are idealised loading condition and the User shall re-analyze the truss for the loading condition which prevail for the application begin considered.

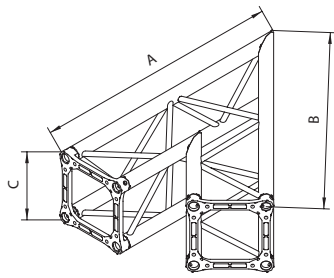

QX30SL2045

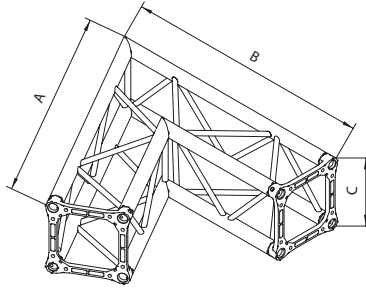

QX30SL2060

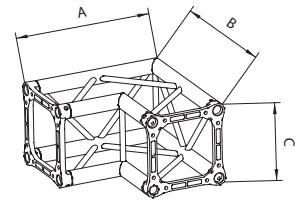

QX30SL2090

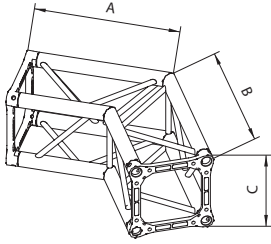

QX30SL2120

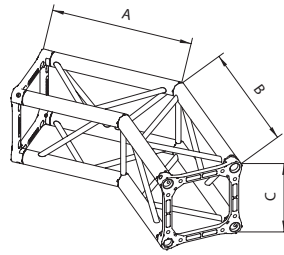

QX30SL2135

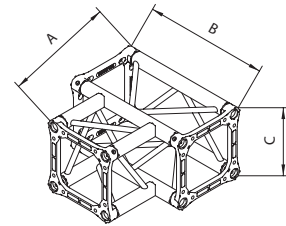

QX30ST3

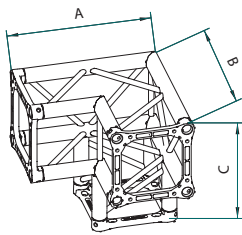

QX30SL3

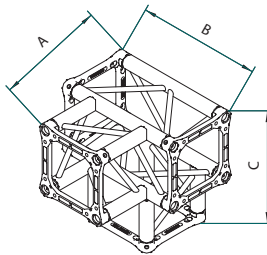

QX30ST4

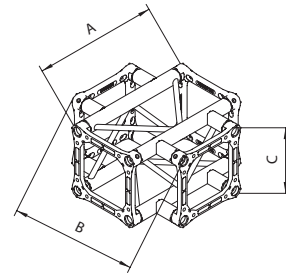

QX30SX4

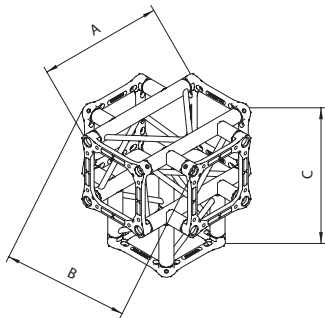

QX30SX5

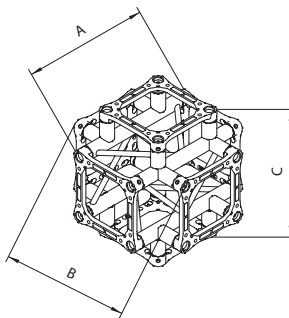

QX30SX6

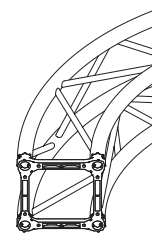

Q = Square truss

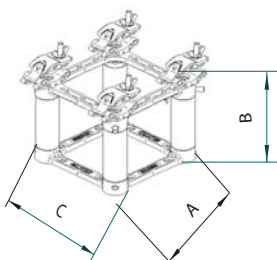

QX30SACL

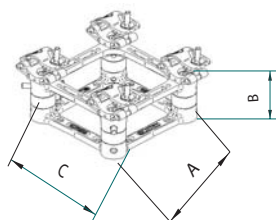

QX30SACS

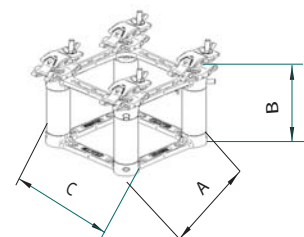

QX30SACSC

**CORNERS**

Code	Dimensions (cm)	Weight (Kg)
QX30K8 (Dado)	29x29x29	9.00
QX30SL2ADJ	50x50x29	7.46
QX30SL2045	100x100x29	8.50
QX30SL2060	100x100x29	9.20
QX30SL2090	50x50x29	5.90
QX30SL2120	50x50x29	6.90
QX30SL2135	50x50x29	6.30
QX30SL3	50x50x50	8.20
QX30ST3	50x50x29	7.30
QX30ST4	50x50x50	9.70
QX30SX4	50x50x29	8.20
QX30SX5	50x50x50	9.90
QX30SX6	50x50x50	11.20
QX30SACL	29x21x29	4.50
QX30SACS	29x10.5x29	4.20
QX30SACSC	29x12.4x29	5.20

**TRUSS**

Code	Dimensions (cm)	Weight (Kg)
QX30S010M5	29x29x10.5	2.90
QX30S021	29x29x21	3.40
QX30S025	29x29x25	3.60
QX30S029	29x29x29	3.80
QX30S050	29x29x50	4.80
QX30S100	29x29x100	7.10
QX30S150	29x29x150	9.50
QX30S200	29x29x200	11.80
QX30S250	29x29x250	14.10
QX30S300	29x29x300	16.50
QX30S350	29x29x350	18.80
QX30S400	29x29x400	21.20

**RINGS**

Curves, rings and ellipses are available on demand

Minimum diameter 2 m

Diameter measurement external

Weight per meter (aprox.) 6 Kg